

Read the [Introduction](#) for more information on these standards, including where to direct comments, questions, and recommendations. As new items are introduced, current items are discontinued, and/or health and safety issues arise, these standards will be revised to provide updated information. Sort by Update Date to view recent changes.

Swivel – Cargo, 6000 lb. Capacity

NFES Status

Active

NFES #

000286

Category

Aviation

Updated

Mon, 05/01/2017 - 12:00

Storage and Shelf Life Checks

None



Initial Inspection/Disposal Criteria

1. Inspect swivel for rotation: Swivel shall rotate freely by hand (no binding) with no load. If swivel does not rotate freely, remove from service. If binding is suspected, perform the following free rotation test. Using a string, hang a 2 lb. weight to the hook. Close the hook and rotate the swivel slowly in one direction and then the other. The speed of rotation shall not be greater than 1 revolution in 5 seconds. If the binding of

the swivel results in the string being carried around the rotation, remove the swivel from service.

Figure 1. Free Rotation Test with 2 lb. Weight

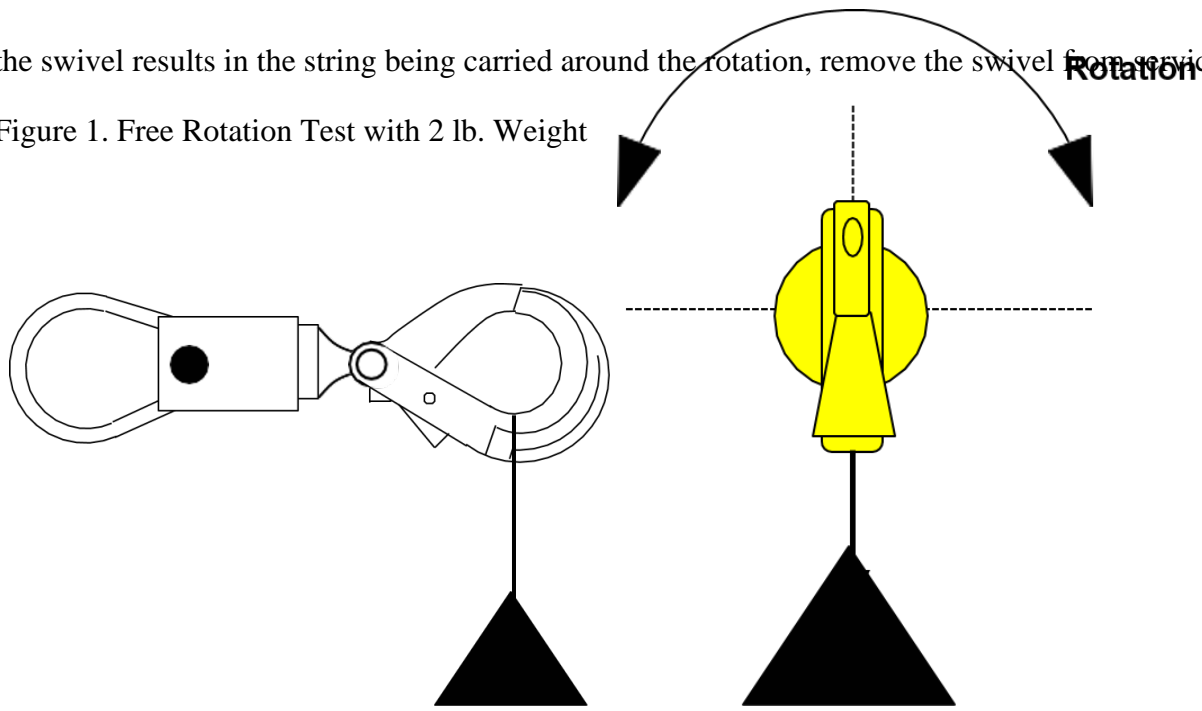

2. Inspect for excessive lateral movement of the swivel. Excessive lateral movement is defined as 5 degrees (angular measurement) of total movement and may indicate bearing wear. Remove from service.

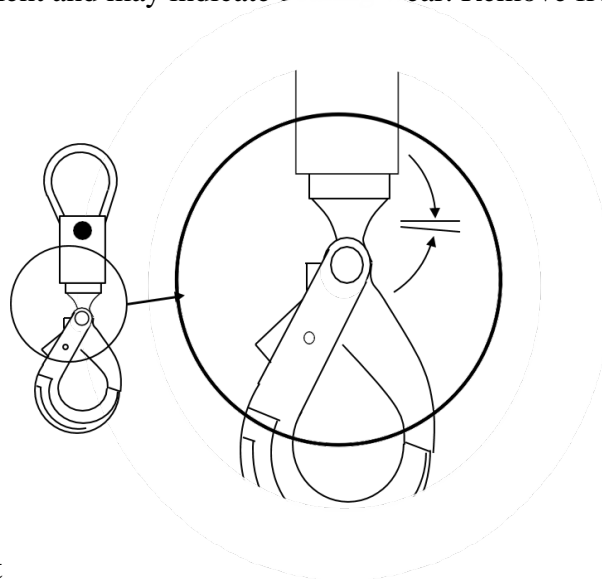

Figure 2. Excessive Lateral Movement

3. Inspect hook and linkage for damage, wear, and deformation:

- a. Inspect swivel rotating body or hook for any cracks or gouges. If cracks or gouges are found, remove from service.
- b. Inspect gate for type. If the gate is a spring gate (the hook opens by pushing the gate into the hook) it is an old style hook and needs replacement. Remove the swivel from service and refer to [NFES Cache Memorandum No. 04-03](#), Cargo Swivel Retrofit Project dated 8/10/04.
- c. Inspect the swivel for the dimensions shown in Figure 3 and Table 1. If dimensions exceed those in Table 1, remove the swivel from service.
- d. Inspect the hook for the dimensions shown in Figure 4 and Table 2. If dimensions exceed those in Table 2, remove the swivel from service.
- e. Check the hook for damage such as cracks, nicks, wear, gouges, and deformation. Check operation and ensure that hook is not bent or distorted. If any damage is found, then remove from service.

Figure 3. Swivel Dimensions; Figure 4. Shank Hook

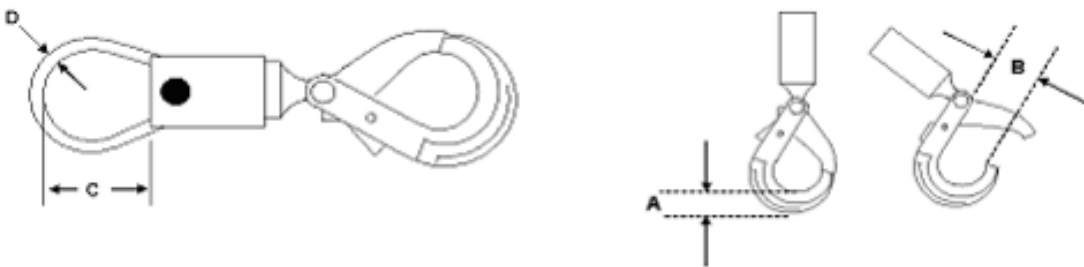

Table 1. Swivel dimensions

Style	C	D
3000 pounds	3 to 5 inch max	5/8 inch nominal
6000 pounds	3 to 5 inch max	5/8 inch nominal

Table 2. Shank Hook Dimensions

Style	A (max)	B (max)
3000 pounds	1.0 inch	1.33 inch
6000 pounds	1.3 inch	1.7 inch

4. Check the hook's locking gate operation.
 - Ensure safety latch open and close completely.
 - Examine latch for damage or distortion.
 - Examine lock latch for rounded lock shoulder, see Figure 5
 - Ensure spring loaded latch hold the latch in the closed position.
 - Ensure lock latch pin is secure and flush with the latch, see Figure 5. If latch is damaged, does not operate as required, is missing hardware, or does not meet dimensional requirements remove from service.

Figure 5 Examine Gate Lock Latch for rounding.

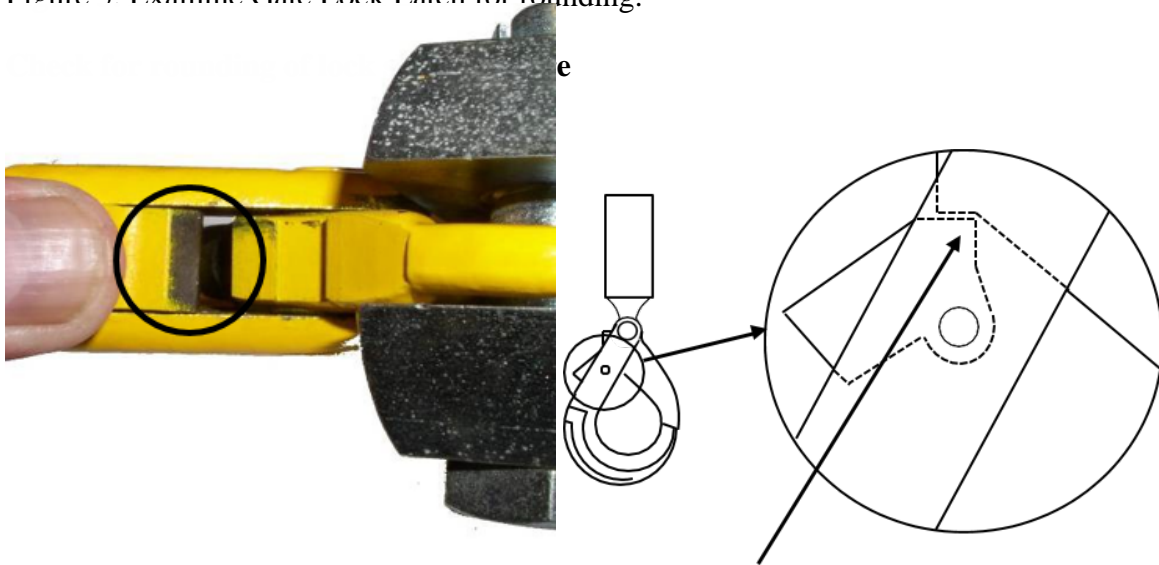

5. Inspect the link and link fastener.

- Check for damage such as cracks, nicks, wear, and gouges.
- Check link for deformations. The curved ends of the link (either oblong or pear) should be generally circular in shape. If overstressing has occurred, the end portions of the link will appear “pinched.” Figure 6 shows the pinched effect of overstressed parts.
- If the link is attached to the swivel with a threaded fastener with nut:
 - Ensure that no more than 2 threads are exposed.
 - Ensure that the fastener has not slipped by inspecting the paint indication. Paint lines that line up indicate no slippage, see Figure 7. If slippage is indicated, refurbish as necessary or dispose of item.
 - Inspect the fastener and nut for damage (cracks and gouges).
 - If the link is attached with a pin secured with roll pins, ensure that the roll pins are not bent or cracked.
 - If damage is observed, refurbish as necessary or dispose of item.

Figure 6. Normal and "pinched" link shapes.

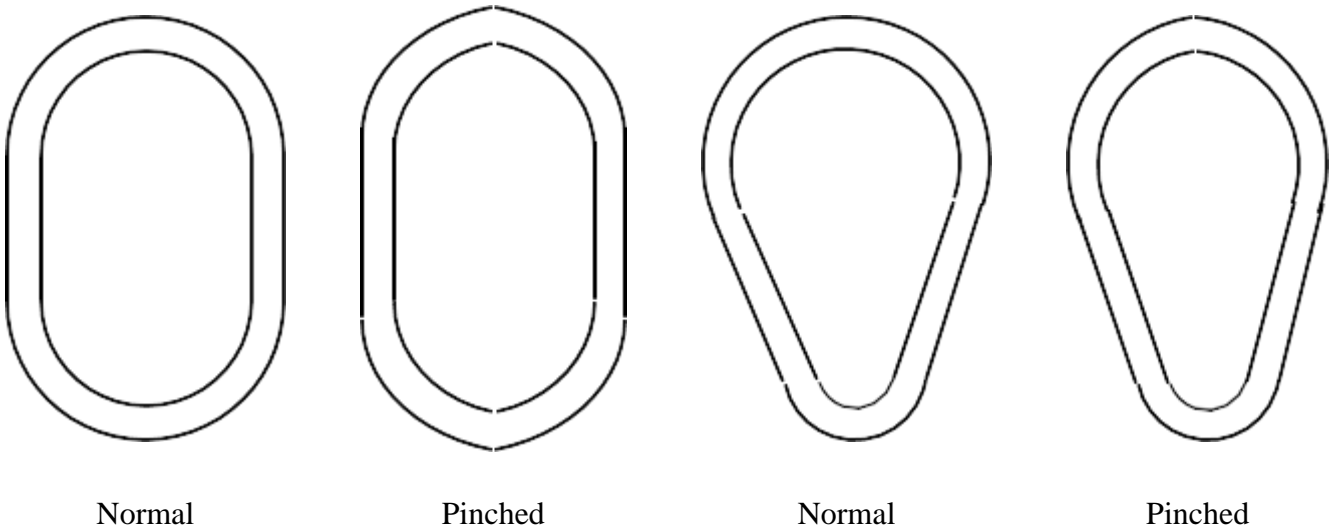
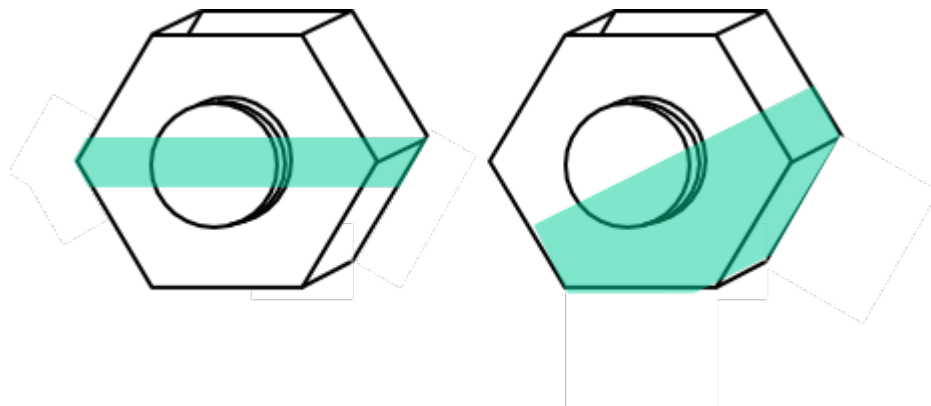

Figure 7. Slippage paint indication.



6. Return to stock if swivel is in sealed packaging and showing signs of usage.
7. Refurbish if swivel has been removed from packaging, is in a used condition, or if deficiencies have been identified in inspection.
8. Dispose of swivel if it fails *Initial Inspection or Testing for Performance* and repairs are not economical feasible to complete.

Refurbishing Procedure

A. Cleaning

1. Wipe clean. Paint as needed.

B. Repair

Never repair, alter, rework, or reshape a hook, link, or swivel. Return to the manufacturer or qualified rigging company for repair.

1. Swivel rotation binding and lateral movement repairs. These repairs shall be performed by the manufacturer or certified/qualified rigging facility. The typical repair is the replacement of the bearing. If the bearing is replaced, the replacement bearing shall be capable of a bearing load 3.75 times the swivel's rated capacity.
2. Hook and link problems. The hooks and links of a swivel shall not be altered, rework, or reshaped. They may be replaced. Replacement components shall have a strength capacity of 3.75 times the load carrying capacity of the swivel. Return the swivel to the manufacturer or certified rigging facility for all replacement parts or repairs.
3. Repaint the fastener slip indicator when necessary. Paint as shown in Figure 7.
4. All above repaired swivels (including replaced components) shall be tested per *Testing for Performance*.
5. Link retaining fastener: Threaded link retaining fasteners that use a bolt and self-locking nut may be retightened in accordance with the Table 3: Link Fastener Torque Values. Paint fasteners as shown in Figure 7. Other fastener systems shall be sent to the manufacturer to be repair.

Table 3. Link Fastener Torque Values

Fastener Size Torque (Ft-lbs.)

5/16	12
3/8	20
7/16	25
1/2	30

C. Testing for performance

1. Repairs must be performed and tested by the manufacturer or certified/qualified rigging facility.
2. Each and every repaired swivel shall be strength tested to 2.0 times its rated capacity. The swivel shall be placed into a tensile style loading device that has a current calibration. The swivel shall be tensile loaded to 2.0 times the rated capacity of the swivel. The swivel shall not show any signs of damage due to loading.
3. Each and every swivel whose bearing is repaired shall pass the following tests:
 - a. Free rotation. Open the hook. Rotate the swivel until the 'jaw' of the hook is down. Rotate the swivel slowly in one direction and then the other. The speed of rotation shall not be greater than 1 revolution in 5 seconds. The jaw should be held (due to gravity) to an orientation less than 135 degrees from vertical, see Figure 8. If the binding of the swivel results in the jaw of the hook rotating over the top the repair is unacceptable.

- b. The lateral movement test described in *Initial Inspection/Disposal Criteria #2*, except that maximum lateral movement shall be less than 2 degrees, see Figure 2.

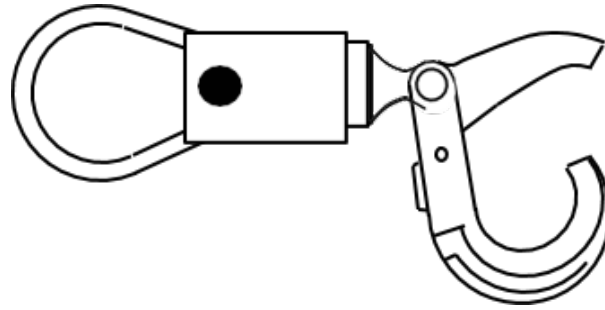
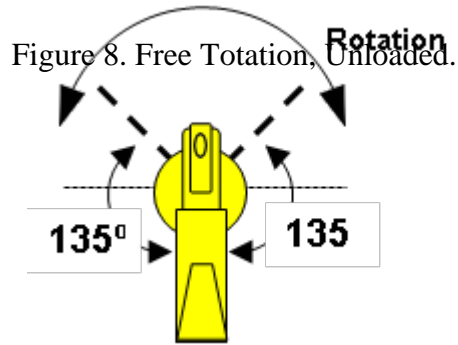

4. All replacement hardware (links, bearings, hooks) shall have a working load limit equal or greater than the working load limit of the corresponding swivel; and have a minimum ultimate strength equal to 11,250 pounds for 3000-lb capacity swivels and 22,500 pounds for 6,000-lb capacity swivels. Links and hooks shall meet the requirements of USDA Forest Service Specification for Swivel, 5100-506 for 6,000-lb swivels and 5100-501a for 3,000-lb swivels.
5. For replaced shank style hooks, the threading of the hook shall follow the hook manufacturer's recommendations.

D. Repackaging

1. NFES #[000526](#) package 6 each in NFES #008018 carton (12" x 12" x 6").
2. NFES #[000286](#) package local cache option.

Reference

NFES Cache Memo No. 04-03;

<https://fs-prod-nwcg.s3.us-gov-west-1.amazonaws.com/s3fs-public/2023-06/nfes-m-04-03.pdf>

https://www.fs.usda.gov/t-d/programs/fire/documents/5100_506.pdf

<https://www.fs.usda.gov/t-d/programs/fire/FY09/documents/5100-501a.pdf>

Swivel – Cargo, 3000 lb. Capacity

NFES Status

Active
NFES #
000526
Category
Aviation
Updated
Mon, 05/01/2017 - 12:00
Storage and Shelf Life Checks
None



Initial Inspection/Disposal Criteria

1. Inspect swivel for rotation: Swivel shall rotate freely by hand (no binding) with no load. If swivel does not rotate freely, remove from service. If binding is suspected, perform the following free rotation test. Using a string, hang a 2 lb. weight to the hook. Close the hook and rotate the swivel slowly in one direction and then the other. The speed of rotation shall not be greater than 1 revolution in 5 seconds. If the binding of the swivel results in the string being carried around the rotation, remove the swivel from service.

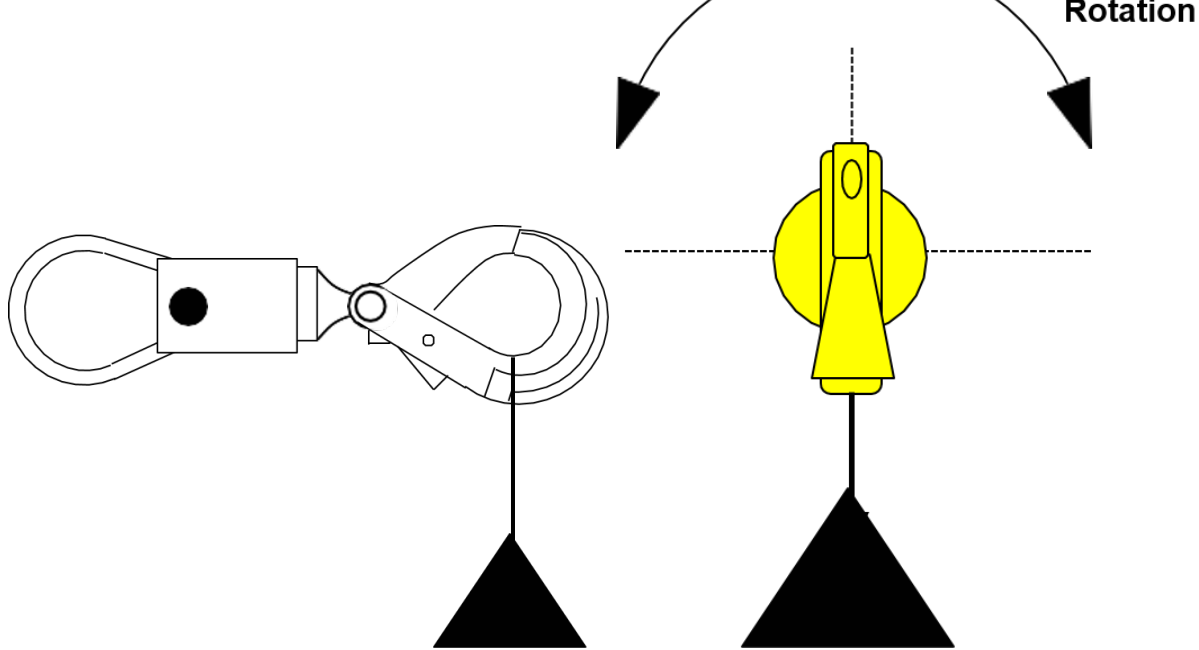

Figure 1. Free Rotation Test with 2 lb. Weight

2. Inspect for excessive lateral movement of the swivel. Excessive lateral movement is defined as 5 degrees (angular measurement) of total movement and may indicate bearing wear. Remove from service.

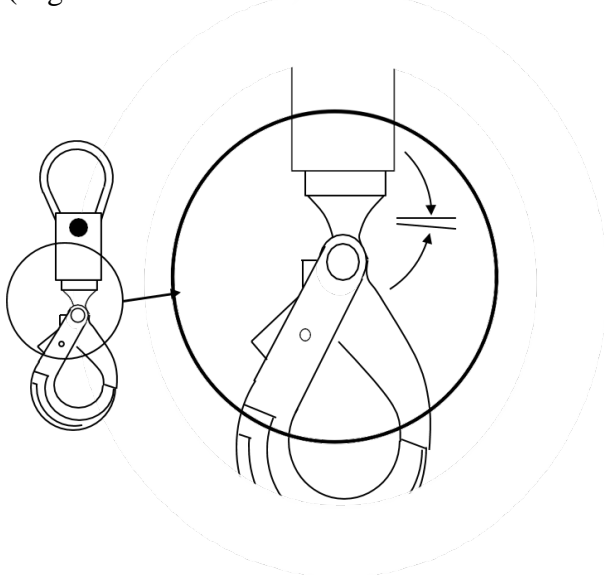

Figure 2. Excessive Lateral Movement

3. Inspect hook and linkage for damage, wear, and deformation:
 - a. Inspect swivel rotating body or hook for any cracks or gouges. If cracks or gouges are found, remove from service.
 - b. Inspect gate for type. If the gate is a spring gate (the hook opens by pushing the gate into the hook) it is an old style hook and needs replacement. Remove the swivel from service and refer to [NFES](#)

[:Cache Memorandum No. 04-03, Cargo Swivel Retrofit Project dated 8/10/04.](#)

- c. Inspect the swivel for the dimensions shown in Figure 3 and Table 1. If dimensions exceed those in Table 1, remove the swivel from service.
- d. Inspect the hook for the dimensions shown in Figure 4 and Table 2. If dimensions exceed those in Table 2, remove the swivel from service.
- e. Check the hook for damage such as cracks, nicks, wear, gouges, and deformation. Check operation and ensure that hook is not bent or distorted. If any damage is found, then remove from service.

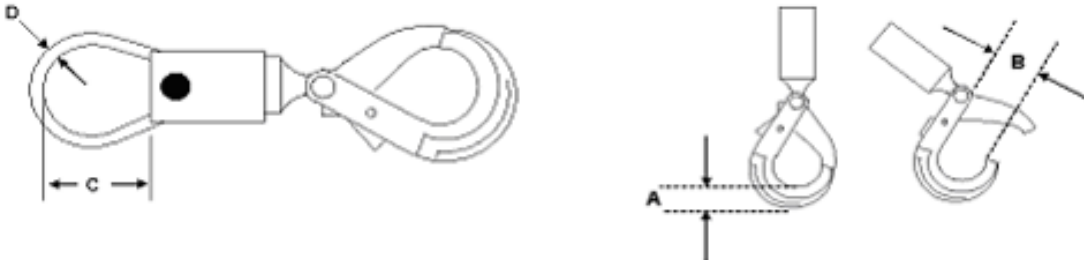

Figure 3. Swivel Dimensions; Figure 4. Shank Hook

Table 1. Swivel dimensions

Style	C	D
3000 pounds	3 to 5 inch	max 5/8 inch nominal
6000 pounds	3 to 5 inch	max 5/8 inch nominal

Table 2. Shank Hook Dimensions

Style	A (max)	B (max)
3000 pounds	1.0 inch	1.33 inch
6000 pounds	1.3 inch	1.7 inch

4. Check the hook's locking gate operation.
 - o Ensure safety latch open and close completely.
 - o Examine latch for damage or distortion.
 - o Examine lock latch for rounded lock shoulder, see Figure 5
 - o Ensure spring loaded latch hold the latch in the closed position.
 - o Ensure lock latch pin is secure and flush with the latch, see Figure 5. If latch is damaged, does not operate as required, is missing hardware, or does not meet dimensional requirements remove from service.

Figure 5. Examine Gate Lock Latch for rounding.

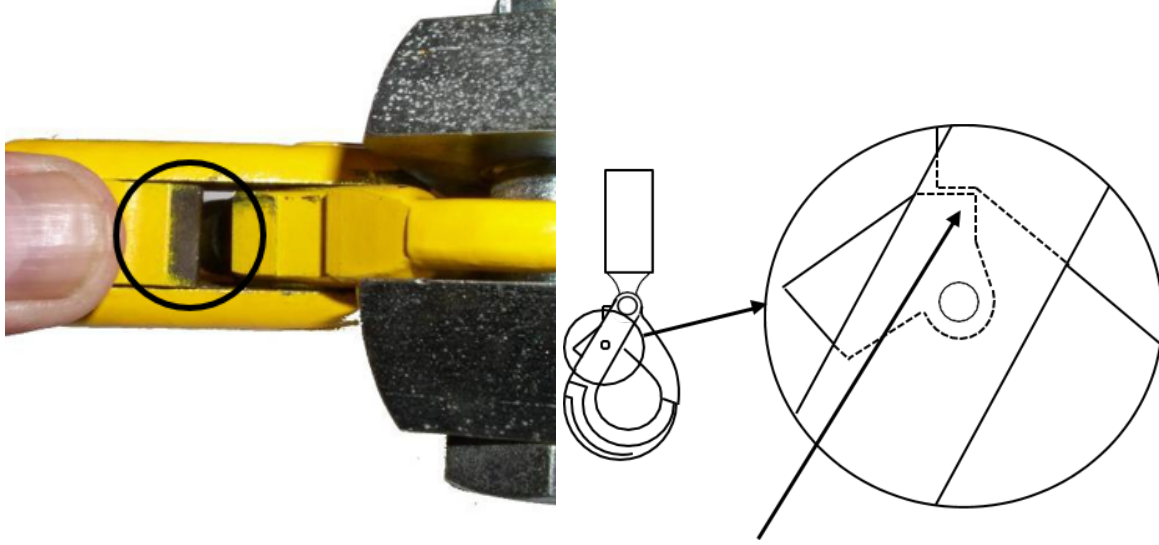

Check for rounding of lock shoulder here

5. Inspect the link and link fastener.
 - Check for damage such as cracks, nicks, wear, and gouges.
 - Check link for deformations. The curved ends of the link (either oblong or pear) should be generally circular in shape. If overstressing has occurred, the end portions of the link will appear “pinched.” Figure 6 shows the pinched effect of overstressed parts.
 - If the link is attached to the swivel with a threaded fastener with nut:
 - Ensure that no more than 2 threads are exposed.
 - Ensure that the fastener has not slipped by inspecting the paint indication. Paint lines that line up indicate no slippage, see Figure 7. If slippage is indicated, refurbish as necessary or dispose of item.
 - Inspect the fastener and nut for damage (cracks and gouges).
 - If the link is attached with a pin secured with roll pins, ensure that the roll pins are not bent or cracked.
 - If damage is observed, refurbish as necessary or dispose of item.

Figure 6. Normal and "pinched" link shapes.

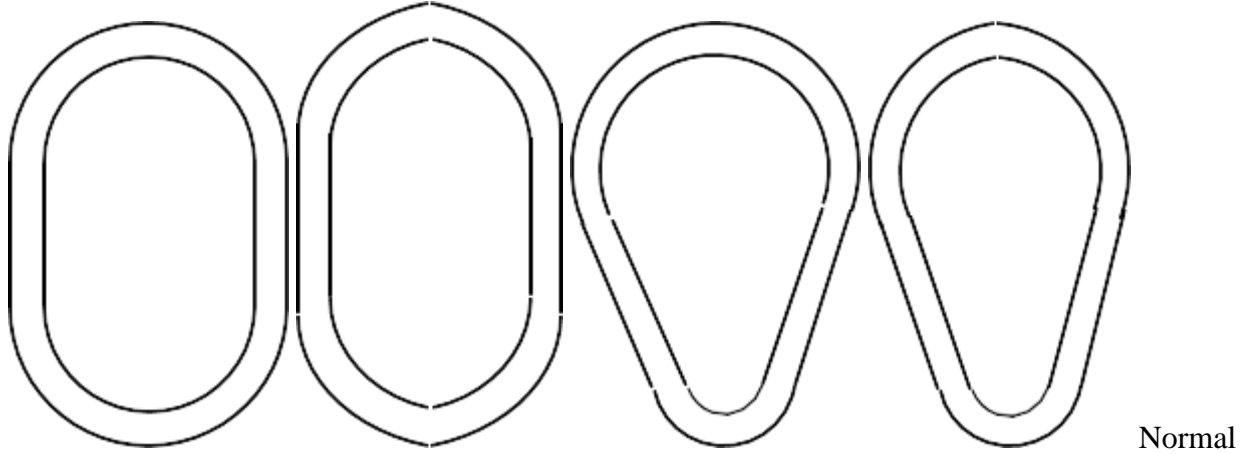
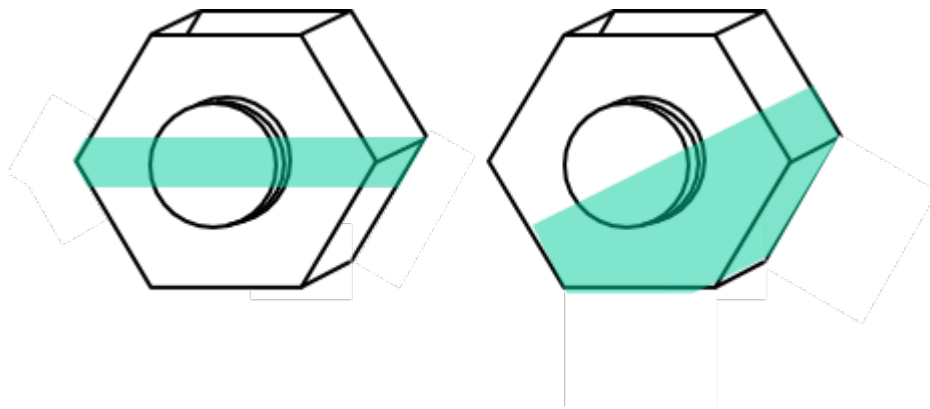

Figure 7. Slippage paint indication.



6. Return to stock if swivel is in sealed packaging and showing signs of usage.
7. Refurbish if swivel has been removed from packaging, is in a used condition, or if deficiencies have been identified in inspection.
8. Dispose of swivel if it fails *Initial Inspection or Testing for Performance* and repairs are not economical feasible to complete.

Refurbishing Procedure

A. Cleaning

1. Wipe clean. Paint as needed.

B. Repair

Never repair, alter, rework, or reshape a hook, link, or swivel. Return to the manufacturer or qualified rigging company for repair.

1. Swivel rotation binding and lateral movement repairs. These repairs shall be performed by the manufacturer or certified/qualified rigging facility. The typical repair is the replacement of the bearing. If the bearing is replaced, the replacement bearing shall be capable of a bearing load 3.75 times the swivel's rated capacity.
2. Hook and link problems. The hooks and links of a swivel shall not be altered, rework, or reshaped. They may be replaced. Replacement components shall have a strength capacity of 3.75 times the load carrying capacity of the swivel. Return the swivel to the manufacturer or certified rigging facility for all replacement parts or repairs.
3. Repaint the fastener slip indicator when necessary. Paint as shown in Figure 7.
4. All above repaired swivels (including replaced components) shall be tested per *Testing for Performance*.
5. Link retaining fastener: Threaded link retaining fasteners that use a bolt and self-locking nut may be retightened in accordance with the Table 3: Link Fastener Torque Values. Paint fasteners as shown in Figure 7. Other fastener systems shall be sent to the manufacturer to be repair.

Table 3. Link Fastener Torque Values

Fastener Size Torque (Ft-lbs.)

5/16	12
3/8	20
7/16	25
1/2	30

C. Testing for performance

1. Repairs must be performed and tested by the manufacturer or certified/qualified rigging facility.
2. Each and every repaired swivel shall be strength tested to 2.0 times its rated capacity. The swivel shall be placed into a tensile style loading device that has a current calibration. The swivel shall be tensile loaded to 2.0 times the rated capacity of the swivel. The swivel shall not show any signs of damage due to loading.
3. Each and every swivel whose bearing is repaired shall pass the following tests:
 - a. Free rotation. Open the hook. Rotate the swivel until the 'jaw' of the hook is down. Rotate the swivel slowly in one direction and then the other. The speed of rotation shall not be greater than 1 revolution in 5 seconds. The jaw should be held (due to gravity) to an orientation less than 135 degrees from vertical, see Figure 8. If the binding of the swivel results in the jaw of

the hook rotating over the top the repair is unacceptable.

- b. The lateral movement test described in *Initial Inspection/Disposal Criteria #2*, except that maximum lateral movement shall be less than 2 degrees, see Figure 2.

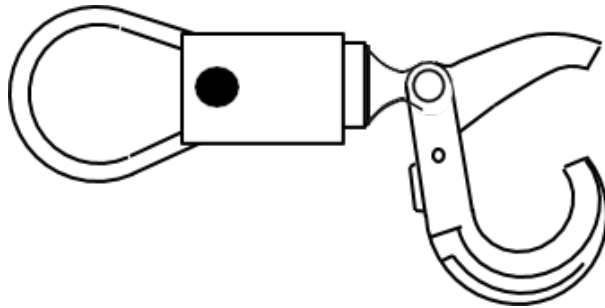
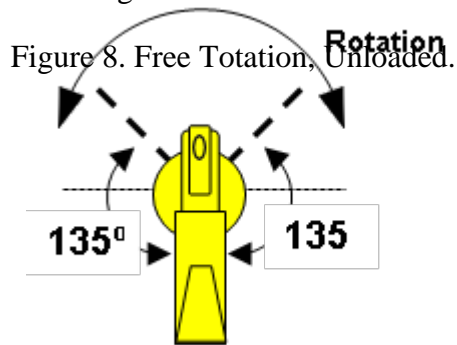

4. All replacement hardware (links, bearings, hooks) shall have a working load limit equal or greater than the working load limit of the corresponding swivel; and have a minimum ultimate strength equal to 11,250 pounds for 3000-lb capacity swivels and 22,500 pounds for 6,000-lb capacity swivels. Links and hooks shall meet the requirements of USDA Forest Service Specification for Swivel, 5100-506 for 6,000-lb swivels and 5100-501a for 3,000-lb swivels.
5. For replaced shank style hooks, the threading of the hook shall follow the hook manufacturer's recommendations.

D. Repackaging

1. NFES #[000526](#) package 6 each in NFES #008018 carton (12" x 12" x 6").
2. NFES #[000286](#) package local cache option.

Reference

[NFES Cache Memo No. 04-03](#)

[6,000 POUND SWIVEL HOOK, EXTERNAL, HELICOPTER, Specification 5100-506](#)

[3,000 POUND SWIVEL HOOK, EXTERNAL, HELICOPTER, Specification 5100-501a](#)

Net – Cargo, 15’X 15’, 6,000 lb. Capacity

NFES Status

Active

NFES #

000458

Category

Aviation

Updated

Sat, 05/01/2021 - 12:00

Storage and Shelf Life Checks

None

Initial Inspection/Disposal Criteria

1. Inspect for fraying or deterioration of lines. Ultraviolet exposure is the most important factor in the degradation of the strength of the cargo nets constructed from polypropylene rope, not use or age. There is no visual or other field inspection technique that will guarantee that a cargo net is free from degradation due to ultraviolet exposure. However, if the net is free of brittleness, has no more than 10 percent broken strands in any two adjacent cycles, and there is no chalking or other visible damage, then the net is probably safe for further use.
 - Inspect for more than 10 percent of strands in any two adjacent cycles of the net being broken.
 - Inspect for brittleness by bending several areas of the nets rope 180 degrees back on itself. If more than two strands break per bend, dispose of net, or return to manufacturer for repair.
 - Inspect for chalking by running a lightly grasped hand over several of the ropes in the net. If small, white, chalk-like fragments of the rope come off in your hand then chalking has occurred. If chalking is present, it is likely that the net has received enough ultraviolet exposure to cause embrittlement and the net must be further inspected for broken strands.
2. Inspect all ropes for fraying, burns, or wear points. All netting cord strands at splices and terminations should be free of fraying and unraveling. Netting terminations on the perimeter rope (purse strings) must have a metal thimble. All splices and terminations shall incorporate a minimum of four tucks back into the netting ropes. All rope terminations and splices should be visually inspected for the minimum number of tucks. Note that due to the length of some of the rope ends past the splice, some rope ends were tucked between other rope strands to constrain the extra rope. This is an acceptable condition for the net.
 - NFES 000458 cargo nets manufactured by Lift-It Manufacturing, Inc. in 2016 under contract number AG-82X9-P-16-6013 will have rubber electrical tape wrapping the polypropylene rope ends. Inspect rope ends to ensure tape is in place. If there is no tape, see [Cache Memo 20-02](#) and taping instructions in Reference Section below for additional information.
3. Inspect netting for contamination by fuel oils or other liquids considered degenerative to netting.
4. Verify an identification tag is attached to every net. If a tag is not attached, attach one but only if the chain of custody can be verified. There are many companies that make similar looking nets that are not of the same capacity. If the chain of custody cannot be verified, the net must be taken to a net manufacturer and proof tested to twice its Workload (e.g., tested to 6,000 lbs.) for a 3,000 lb. net. (Note: It has been found that the cost to perform this test for a net missing its tag is about $\frac{3}{4}$ the cost of new net. The custodian of the net should consider the economics before sending the net out for proof testing.)

- Replacement tag info should include NFES #, Working Load Limit (WLL) in pounds, i.e., 3,000 lbs. /6,000 lbs., cache identifier and date.
 - Inspect loop thimbles for cracks, wear, and deformation. Ensure thimbles are not loose from net and easily removed.
 - On some heavy cargo nets (NFES #000458), the mesh intersections are fixed with molded plastic crosses. These should be visually inspected for cracks and missing parts. Remove from service if broken or missing components are identified.
 - Any NFES #000795 net that is constructed of black mesh must be taken out of service.
 - Return to stock if items pass inspection, are clean, and in unused condition.
 - Refurbish if deemed necessary through inspection and repairs economically feasible.
5. Dispose of item if refurbishment or repair will not correct deficiencies identified during the inspection process.

Refurbishing Procedures

A. Cleaning

1. Clean all dirt from netting.
2. Remove all flagging, string, and rope.
3. Hang or stack polypropylene nets and clean with water from high-pressure hose.
4. Dry completely before packaging.

B. Repairs

Any repairs should be completed by net manufacturers.

C. Testing for Performance

none

D. Repackaging

Suggested cartons are:

- Package 1 each in NFES #000645 carton (42" X 13.5" X 14")

Net – Cargo, 12' X 12', Polypropylene, 3000 lbs. Capacity

NFES Status

Active

NFES #

000531

Category

Aviation

Initial Inspection/Disposal Criteria

1. Inspect for fraying or deterioration of lines. Ultra violet exposure is the most important factor in the degradation of the strength of the cargo nets constructed from polypropylene rope, not use or age. There is no visual or other field inspection technique that will guarantee that a cargo net is free from degradation due to ultraviolet exposure. However, if the net is free of brittleness, has no more than 10 percent broken strands in any two adjacent cycles, and there is no chalking or other visible damage, then the net is probably safe for further use.
 - Inspect for more than 10 percent of strands in any two adjacent cycles of the net being broken.
 - Inspect for brittleness by bending several areas of the nets rope 180° back on itself. If more than 2 strands break per bend, dispose of net or return to manufacturer for repair.
 - Inspect for chalking by running a lightly grasped hand over several of the ropes in the net. If small, white, chalk-like fragments of the rope come off in your hand then chalking has occurred. If chalking is present, it is likely that the net has received enough ultraviolet exposure to cause embrittlement and the net must be further inspected for broken strands.
2. Inspect all ropes for fraying, burns, or wear points.
3. Inspect netting for contamination by fuel oils or other liquids considered degenerative to netting.
4. Verify an identification tag is attached to every net. If a tag is not attached, attach one but only if the chain of custody can be verified. There are many companies that make similar looking nets that are not of the same capacity. If the chain of custody cannot be verified, the net must be taken to a net manufacturer and proof tested to twice its Work Load (e.g. tested to 6,000 lbs. for a 3,000 lb. net. (Note: It has been found that the cost to perform this test for a net missing its tag is about $\frac{3}{4}$ the cost of new net. The custodian of the net should consider the economics before sending the net out for proof testing.)
 - Replacement tag info should include NFES #, Working Load Limit (WLL) in pounds, i.e., 3,000 lbs. /6,000 lbs., cache identifier and date.
 - Inspect loop thimbles for cracks, wear, and deformation. Ensure thimbles are not loose from net and easily removed.
 - On some heavy cargo nets (NFES #[000458](#)), the mesh intersections are fixed with molded plastic crosses. These should be visually inspected for cracks and missing parts. Remove from service if broken or missing components are identified.
 - Any NFES #[000795](#) net that is constructed of black mesh must be taken out of service.
 - Return to stock if items pass inspection, are clean, and in unused condition.
 - Refurbish if deemed necessary through inspection and repairs economically feasible.
 - Dispose of item if refurbishment or repair will not correct deficiencies identified during the inspection process.

Refurbishing Procedures

A. Cleaning

1. Clean all dirt from netting.
2. Remove all flagging, string, and rope.
3. Hang or stack polypropylene nets and clean with water from high-pressure hose.
4. Dry completely before packaging.

B. Repairs

Any repairs should be completed by net manufacturers. 76 NFES #[000531](#) NFES #[000458](#)

C. Testing for Performance

none

D. Repackaging

Suggested cartons are:

- NFES #[000531](#), package 1 each in NFES #002006 carton (23" X 19" X 10").
- NFES #[000458](#), package 1 each in NFES #002007 carton (24" X 16" X 16").
- NFES #[000795](#), package 1 each in NFES #008064 carton (10" X 8" X 6").

Net – Cargo, 10’X10’, 300 LB Capacity, Lightweight

NFES Status

Active

NFES #

000795

Category

Aviation

Updated

Mon, 05/01/2017 - 12:00

Storage and Shelf Life Checks

None

Initial Inspection/Disposal Criteria

1. Inspect for fraying or deterioration of lines. Ultra violet exposure is the most important factor in the degradation of the strength of the cargo nets constructed from polypropylene rope, not use or age. There is no visual or other field inspection technique that will guarantee that a cargo net is free from degradation due to ultraviolet exposure. However, if the net is free of brittleness, has no more than 10 percent broken strands in any two adjacent cycles, and there is no chalking or other visible damage, then the net is probably safe for further use.

- Inspect for more than 10 percent of strands in any two adjacent cycles of the net being broken.
 - Inspect for brittleness by bending several areas of the nets rope 180° back on itself. If more than 2 strands break per bend, dispose of net or return to manufacturer for repair.
 - Inspect for chalking by running a lightly grasped hand over several of the ropes in the net. If small, white, chalk-like fragments of the rope come off in your hand then chalking has occurred. If chalking is present, it is likely that the net has received enough ultraviolet exposure to cause embrittlement and the net must be further inspected for broken strands.
2. Inspect all ropes for fraying, burns, or wear points.
 3. Inspect netting for contamination by fuel oils or other liquids considered degenerative to netting.
 4. Verify an identification tag is attached to every net. If a tag is not attached, attach one but only if the chain of custody can be verified. There are many companies that make similar looking nets that are not of the same capacity. If the chain of custody cannot be verified, the net must be taken to a net manufacturer and proof tested to twice its Work Load (e.g. tested to 6,000 lbs. for a 3,000 lb. net. (Note: It has been found that the cost to perform this test for a net missing its tag is about $\frac{3}{4}$ the cost of new net. The custodian of the net should consider the economics before sending the net out for proof testing.)
 - Replacement tag info should include NFES #, Working Load Limit (WLL) in pounds, i.e., 3,000 lbs. /6,000 lbs., cache identifier and date.
 - Inspect loop thimbles for cracks, wear, and deformation. Ensure thimbles are not loose from net and easily removed.
 - On some heavy cargo nets (NFES #[000458](#)), the mesh intersections are fixed with molded plastic crosses. These should be visually inspected for cracks and missing parts. Remove from service if broken or missing components are identified.
 - Any NFES #[000795](#) net that is constructed of black mesh must be taken out of service.
 - Return to stock if items pass inspection, are clean, and in unused condition.
 - Refurbish if deemed necessary through inspection and repairs economically feasible.
 - Dispose of item if refurbishment or repair will not correct deficiencies identified during the inspection process.

Refurbishing Procedures

A. Cleaning

1. Clean all dirt from netting.
2. Remove all flagging, string, and rope.
3. Hang or stack polypropylene nets and clean with water from high-pressure hose.
4. Dry completely before packaging.

B. Repairs

Any repairs should be completed by net manufacturers. 76 NFES #[000531](#) NFES #[000458](#)

C. Testing for Performance

none

D. Repackaging

Suggested cartons are:

- NFES #[000531](#), package 1 each in NFES #002006 carton (23" X 19" X 10").
- NFES #[000458](#), package 1 each in NFES #002007 carton (24" X 16" X 16").
- NFES #[000795](#), package 1 each in NFES #008064 carton (10" X 8" X 6").

Leadline – Helicopter, External Loads, 6,000 lbs.

NFES Status

Active

NFES #

000380

Category

Aviation

Updated

Mon, 05/01/2017 - 12:00

Storage and Shelf Life Checks

None

Initial Inspection/Disposal Criteria

1. Inspect eye and swage for red paint and slippage:
 - a. Inspect swage and wire rope eyes for slippage. If slippage has occurred, see Figures 1 and 2, dispose of the leadline.
 - b. Visually inspect each swage and eye for red paint, if the paint shows that slippage has not occurred, but the paint is worn in such a way that this determination was difficult, the swage shall be repainted. If paint is not present, send to certified rigging specialist for evaluation.



Figure 1. Painted Swage

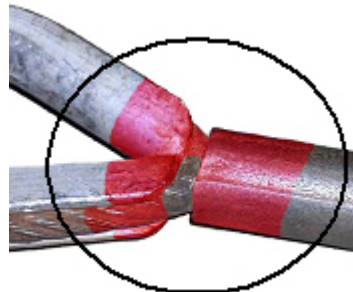

Figure 2. Paint showing slippage

2. Inspect for wire rope damage. If any damage is found then dispose of the wire rope.

a. Visually inspect length of wire rope for structural damage

- Kinks in wire rope, see Figure 3.
- Ballooning of wire rope, see Figure 4.
- Cut or damaged plastic coating of cable (NFES #[000528](#) only), see Figure 5.
- Severe Corrosion
- Abrasion, wear over 1/3 the outer wire diameter, see Figure 6.
- Reduction in diameter of wire rope.



Figure 3. Kink



Figure 4. Ballooning



Figure 5. Damaged plastic coated wire rope.



Figure 6. Abrasion

b. 6000 pound leadline (NFES #[000380](#))--inspect length of wire rope for damage.

- Wear heavy protective gloves. Never use an ungloved hand to check the length of the cable.
- Run a dry rag over the entire length of the wire rope.

- Flex wire rope to expose breaks. Snags indicate broken wires in the wire rope. If individual broken wires are found, they may be trimmed back. If 4 or more broken wires are found grouped together, then dispose of wire rope.
- c. 3000 pound leadline (NFES #000528)--inspect plastic coated wire rope for damage. Abrasion to plastic coating down to the wire rope may cause corrosion.
- Run gloved hand over length of plastic coated wire rope to check for any abnormalities such as lumps, depressions, and exposed wire. If plastic coated wire rope has severe damage or corrosion, dispose of properly. See Figure 5.

3. Measure wire rope diameter and length-

a. Check wire rope length.

- Length is measured from center of each thimble. If wire rope length exceeds tolerance, dispose of properly. Note: A hook replacement process was performed where old style spring gate hooks were replaced with self-closing gate hooks, see *References*. In this retrofit process the leadline length was shortened. The minimum length of the leadline was set at 10 ft. 2 inches. Further as part of the retrofit, the ID tag was to include “Retrofit Leadline.” Therefore short 3,000 lb. rated leadlines are only acceptable if they include the Retrofit Leadline designation on their ID tags, others are to be removed from service.

Table 1. Wire Rope Length

Length Tolerance per FSS 5100-503/505

12 feet	+/-3 inches
25 feet	+/-3 inches
50 feet	+/-3 inches

Table 2. Wire Rope Diameter

Size	Dimension
3000 lbs.	5/16 inch to 5/8 inch
6000 lbs.	1/2 inch to 9/16 inch

4. Check for identification.
- a. Visually inspect leadline for permanently attached tag. Proof load tag shall be permanently attached with a swaged stainless steel wire rope.
 - b. Temporary attachments are not allowed, such as wire ties.
 - c. Tag shall contain at a minimum the following information: Manufacture Name, Test Company or Trademark; Working Load Limit; and Date of Proof Test (i.e., 06/06 for June, 2006). Note: Older leadlines will have Safe Working Load vice Working Load Limit, both terms are currently

acceptable.

- d. If permanently attached proof load tag is not present, missing required information, not made of metal or secured with a non-permanent attachment device (e.g. Ty-Rap zip ties), remove the leadline from service.
5. Inspect thimble for cracks, wear, and deformation.
- a. Physically examine each thimble for movement by forceful motion with hand.
 - b. Thimble may move but should not be loose within the eyelet.
 - c. Thimble shall have a smooth arc (see Figure 7.) If thimbles have any cracks, wear, deformation or are loose (see Figure 8.), dispose of leadline.



Figure 7. Thimble, Pear Link and Proof Load Tag

Figure 8. Deformed Thimble and Hook

6. Inspect hook for damage, wear, and deformation.
- a. Check hook for damage such as cracks, nicks, wear, gouges, and deformation, see Figures 9 and 10.
 - b. Ensure that hook is not bent or distorted and complies with hook dimensions, see Table 3 and Figure 9.
 - c. Ensure hook has a safety latch or has been retrofit with self-locking safety gate that operates correctly.
 - Ensure safety gate opens and closes completely.
 - Examine gate for damage or distortion.
 - Examine gate lock for rounded edge, see Figure 10.
 - Ensure lock latch pin is secure and flush with latch, see Figure 10.
- a. Check hook dimensions, see Table 3 and Figure 9.
 - b. If hook is damaged, missing hardware, is distorted, or does not meet dimension requirements, remove leadline from service.

Table 3. Hook Dimensions

Leadline Capacity	Style	H (max)	J (min)
3000 lbs.	Self-locking hook	1.0 inch	1.33 inches
6000 lbs.	Self-locking hook	1.33 inches	1.7 inches

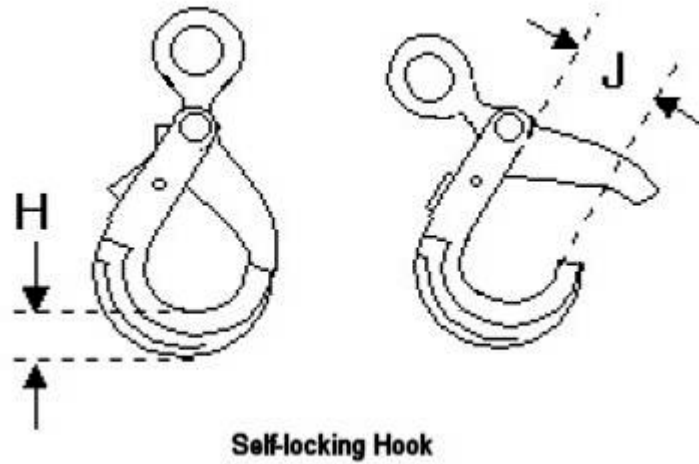

Figure 9. Dimensions for Hooks

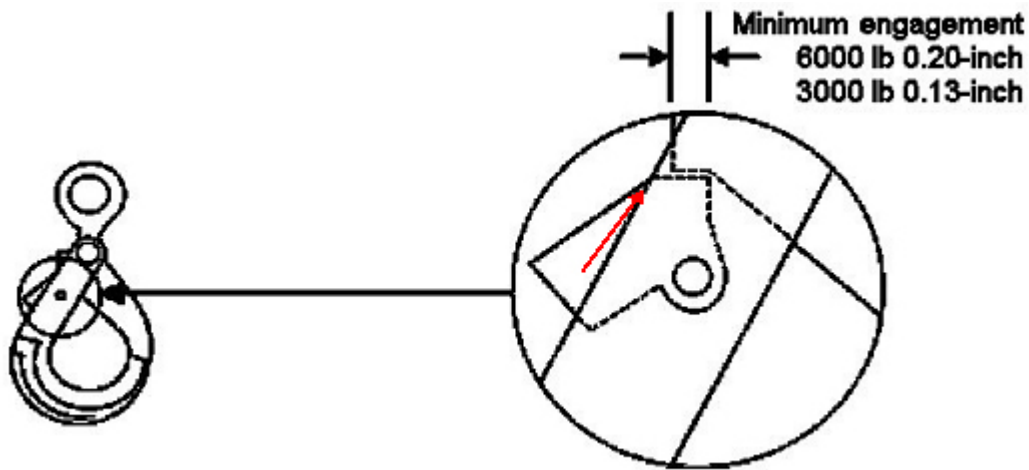

Figure 10. Examine Gate Lock Latch for rounding.

7. Inspect Ring or Link

- a. Check for damage such as cracks, nicks, wear, and gouges.
- b. Check dimensions for deformations, see Table 4 and Figure 11.
- c. If ring or link is damaged, remove from service.

Table 4. Leadline Ring and Pear Link Dimensions

Leadline	A	B	C
3000 lb Leadline	5/8 inch max	1.5 - 3 inch	3 - 4 inch
6000 lb Leadline	0.63 inch max	1.5 - 3 inch	3 - 4.5 inch

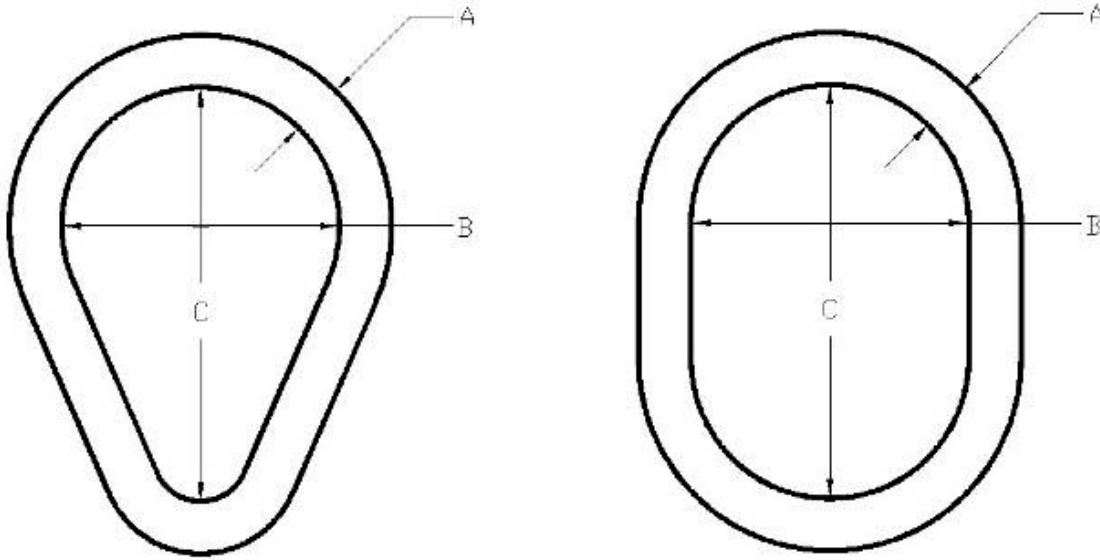

Figure 11. Dimension for Pear Link and Oblong Link.

8. Return to stock if leadline is in a sealed carton, or is an open container, but is clean, in unused condition, and passes inspection.
9. Refurbish if leadline only requires cleaning or has deficiencies identified during inspection that are economically feasible to complete.
10. Dispose of leadline if it fails inspection and repairs are not practical or economically feasible.

Refurbishing Procedures

A. Cleaning

- The cable and hook assembly may be cleaned with hot water only, no soap.

B. Repair

1. Apply slippage paint to the swage and thimble as shown in Figure 12.
 - The paint shall be a red spray epoxy or acrylic.

- Mask or cover the area to achieve a painted area similar to Figure 12.
 - Spray around the swage and do not attempt to spray paint into the ends of swage.
2. If the Proof Load Tag is missing, the leadline must be sent to a rigging company to be tested per Testing for Performance, as long as the item passed all other inspections.
 3. Upon successful test, the rigging company shall apply a Proof Load Tag that meets/includes the following:
 - Working Load Limit in lbs. • date of proof test (month and year)
 - Name or trademark of the rigging company
 - Text size shall be 0.12 inches in height
 - Tag shall either be stainless steel or brass
 - Tag shall be secured to the leadline with a metal device, e.g., 'hog ring', wire cable



Figure 12. Swage Paint.

C. Testing for Performance

1. Proof tests must be performed by a certified rigging company when the tag is missing and the leadline is otherwise acceptable and it's economically feasible to retest the leadline.
2. The proof test shall apply a load to the item at twice the rated safe working load.
3. Any certified rigging company can test proof test the leadline assembly.

D. Repackaging

NFES #000528 package 5 each in NFES #008018 carton (12" x 12" x 6").

NFES #000380 suggested package of 1 each in NFES #008018 carton (12" x 12" x 6").

Leadline – 12', 3000 lb. Capacity

NFES Status

Active

NFES #

000528

Category

Aviation

Updated

Mon, 05/01/2017 - 12:00

Storage and Shelf Life Checks

None

Initial Inspection/Disposal Criteria

1. Inspect eye and swage for red paint and slippage:
 - a. Inspect swage and wire rope eyes for slippage. If slippage has occurred, see Figures 1 and 2, dispose of the leadline.
 - b. Visually inspect each swage and eye for red paint, if the paint shows that slippage has not occurred, but the paint is worn in such a way that this determination was difficult, the swage shall be repainted. If paint is not present, send to certified rigging specialist for evaluation.



Figure 1. Painted Swage

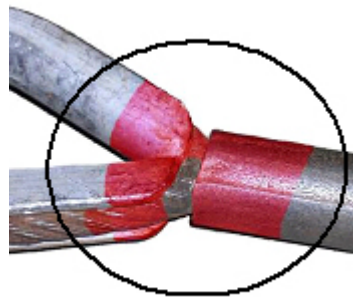

Figure 2. Paint showing slippage

2. Inspect for wire rope damage. If any damage is found then dispose of the wire rope.
 - a. Visually inspect length of wire rope for structural damage
 - Kinks in wire rope, see Figure 3.
 - Ballooning of wire rope, see Figure 4.
 - Cut or damaged plastic coating of cable (NFES #000528 only), see Figure 5.

- Severe Corrosion
- Abrasion, wear over 1/3 the outer wire diameter, see Figure 6.
- Reduction in diameter of wire rope.

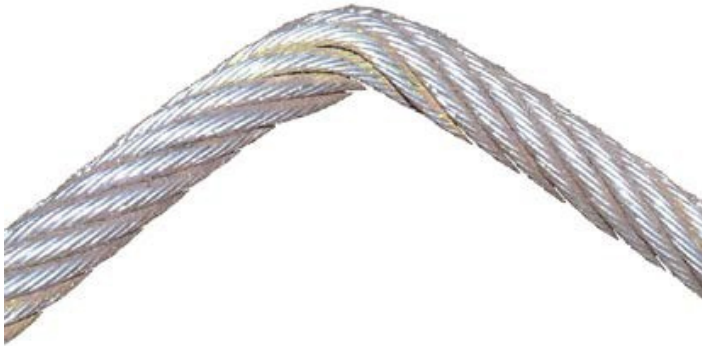

Figure 3. Kink



Figure 4. Ballooning



Figure 5. Damaged plastic coated wire rope.



Figure 6. Abrasion

b. 6000 pound leadline (NFES [#000380](#))--inspect length of wire rope for damage.

- Wear heavy protective gloves. Never use an ungloved hand to check the length of the cable.
- Run a dry rag over the entire length of the wire rope.
- Flex wire rope to expose breaks. Snags indicate broken wires in the wire rope. If individual broken wires are found, they may be trimmed back. If 4 or more broken wires are found grouped together, then dispose of wire rope.

c. 3000 pound leadline (NFES [#000528](#))--inspect plastic coated wire rope for damage. Abrasion to plastic coating down to the wire rope may cause corrosion.

- Run gloved hand over length of plastic coated wire rope to check for any abnormalities such as lumps, depressions, and exposed wire. If plastic coated wire rope has severe damage or corrosion, dispose of properly. See Figure 5.
3. Measure wire rope diameter and length-
- a. Check wire rope length.
- Length is measured from center of each thimble. If wire rope length exceeds tolerance, dispose of properly. Note: A hook replacement process was performed where old style spring gate hooks were replaced with self-closing gate hooks, see *References*. In this retrofit process the leadline length was shortened. The minimum length of the leadline was set at 10 ft. 2 inches. Further as part of the retrofit, the ID tag was to include “Retrofit Leadline.” Therefore short 3,000 lb. rated leadlines are only acceptable if they include the Retrofit Leadline designation on their ID tags, others are to be removed from service.

Table 1. Wire Rope Length

Length Tolerance per FSS 5100-503/505

12 feet	+/-3 inches
25 feet	+/-3 inches
50 feet	+/-3 inches

Table 2. Wire Rope Diameter

Size	Dimension
3000 lbs.	5/16 inch to 5/8 inch
6000 lbs.	1/2 inch to 9/16 inch

4. Check for identification.
 - a. Visually inspect leadline for permanently attached tag. Proof load tag shall be permanently attached with a swaged stainless steel wire rope.
 - b. Temporary attachments are not allowed, such as wire ties.
 - c. Tag shall contain at a minimum the following information: Manufacture Name, Test Company or Trademark; Working Load Limit; and Date of Proof Test (i.e., 06/06 for June, 2006). Note: Older leadlines will have Safe Working Load vice Working Load Limit, both terms are currently acceptable.
 - d. If permanently attached proof load tag is not present, missing required information, not made of metal or secured with a non-permanent attachment device (e.g. Ty-Rap zip ties), remove the leadline from service.
5. Inspect thimble for cracks, wear, and deformation.
 - a. Physically examine each thimble for movement by forceful motion with hand.
 - b. Thimble may move but should not be loose within the eyelet.

- c. Thimble shall have a smooth arc (see Figure 7.) If thimbles have any cracks, wear, deformation or are loose (see Figure 8.), dispose of leadline.



Figure 7. Thimble, Pear Link and Proof Load Tag

Figure 8. Deformed Thimble and Hook

6. Inspect hook for damage, wear, and deformation.
- a. Check hook for damage such as cracks, nicks, wear, gouges, and deformation, see Figures 9 and 10.
 - b. Ensure that hook is not bent or distorted and complies with hook dimensions, see Table 3 and Figure 9.
 - c. Ensure hook has a safety latch or has been retrofit with self-locking safety gate that operates correctly.
 - Ensure safety gate opens and closes completely.
 - Examine gate for damage or distortion.
 - Examine gate lock for rounded edge, see Figure 10.
 - Ensure lock latch pin is secure and flush with latch, see Figure 10.
- a. Check hook dimensions, see Table 3 and Figure 9.
 - b. If hook is damaged, missing hardware, is distorted, or does not meet dimension requirements, remove leadline from service.

Table 3. Hook Dimensions

Leadline Capacity	Style	H (max)	J (min)
3000 lbs.	Self-locking hook	1.0 inch	1.33 inches
6000 lbs.	Self-locking hook	1.33 inches	1.7 inches

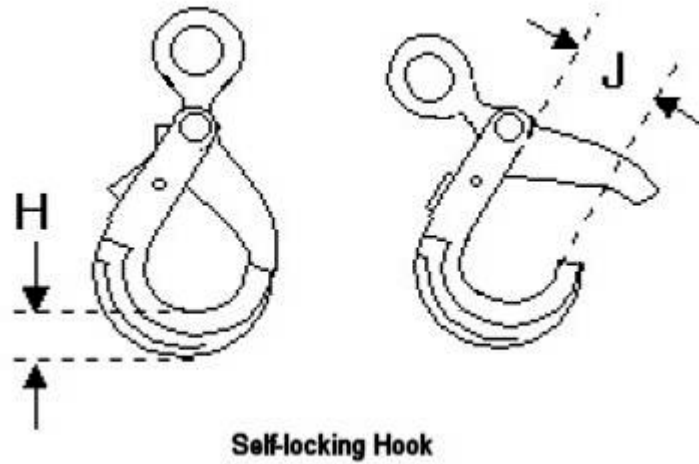

Figure 9. Dimensions for Hooks

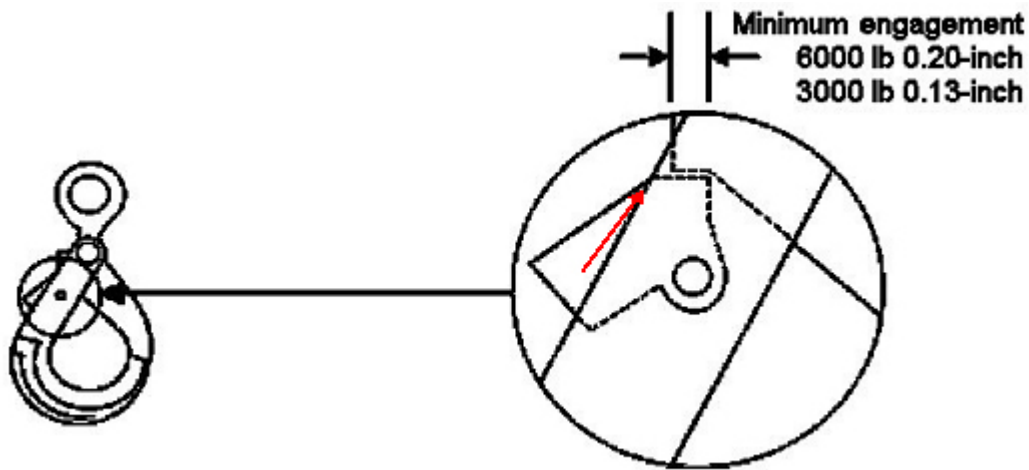

Figure 10. Examine Gate Lock Latch for rounding.

7. Inspect Ring or Link

- a. Check for damage such as cracks, nicks, wear, and gouges.
- b. Check dimensions for deformations, see Table 4 and Figure 11.
- c. If ring or link is damaged, remove from service.

Table 4. Leadline Ring and Pear Link Dimensions

Leadline	A	B	C
3000 lb Leadline	5/8 inch max	1.5 - 3 inch	3 - 4 inch
6000 lb Leadline	0.63 inch max	1.5 - 3 inch	3 - 4.5 inch

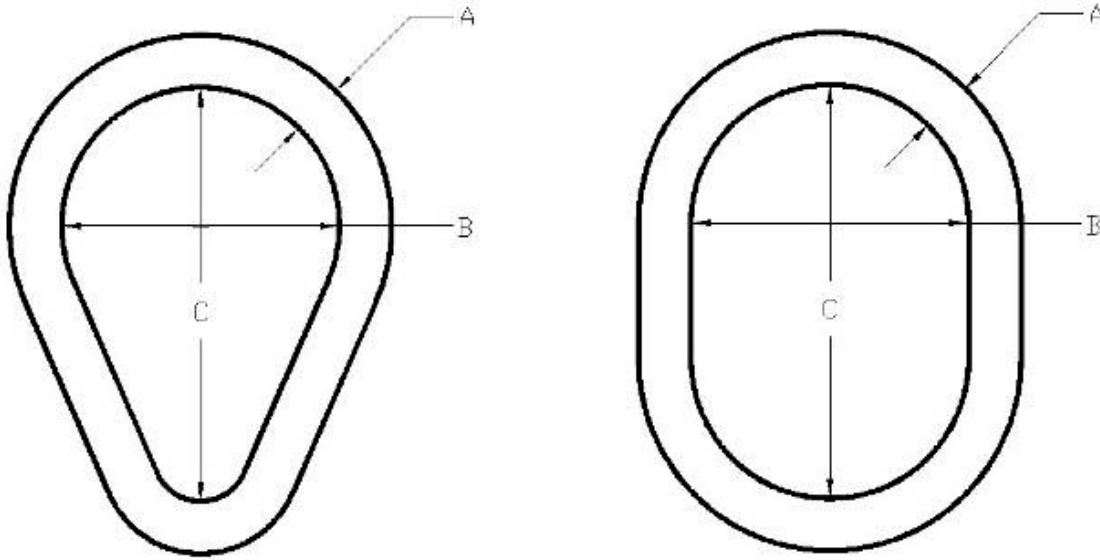

Figure 11. Dimension for Pear Link and Oblong Link.

8. Return to stock if leadline is in a sealed carton, or is an open container, but is clean, in unused condition, and passes inspection.
9. Refurbish if leadline only requires cleaning or has deficiencies identified during inspection that are economically feasible to complete.
10. Dispose of leadline if it fails inspection and repairs are not practical or economically feasible.

Refurbishing Procedures

A. Cleaning

- The cable and hook assembly may be cleaned with hot water only, no soap.

B. Repair

1. Apply slippage paint to the swage and thimble as shown in Figure 12.
 - The paint shall be a red spray epoxy or acrylic.

- Mask or cover the area to achieve a painted area similar to Figure 12.
 - Spray around the swage and do not attempt to spray paint into the ends of swage.
2. If the Proof Load Tag is missing, the leadline must be sent to a rigging company to be tested per Testing for Performance, as long as the item passed all other inspections.
 3. Upon successful test, the rigging company shall apply a Proof Load Tag that meets/includes the following:
 - Working Load Limit in lbs. • date of proof test (month and year)
 - Name or trademark of the rigging company
 - Text size shall be 0.12 inches in height
 - Tag shall either be stainless steel or brass
 - Tag shall be secured to the leadline with a metal device, e.g., 'hog ring', wire cable



Figure 12. Swage Paint.

C. Testing for Performance

1. Proof tests must be performed by a certified rigging company when the tag is missing and the leadline is otherwise acceptable and it's economically feasible to retest the leadline.
2. The proof test shall apply a load to the item at twice the rated safe working load.
3. Any certified rigging company can test proof test the leadline assembly.

D. Repackaging

NFES #000528 package 5 each in NFES #008018 carton (12" x 12" x 6").

NFES #000380 suggested package of 1 each in NFES #008018 carton (12" x 12" x 6").

Helmet – Flight, SPH-5C, X-Large, w/Bag

NFES Status

Active

NFES #

002315

Category

Aviation

Updated

Mon, 05/01/2017 - 12:00

Storage and Shelf Life Checks

None

Initial Inspection/Disposal Criteria

1. If helmet carton is unopened inspect carton for signs of crushing, drops or water damage. If carton is damaged, open and inspect helmet following remaining inspection processes.
2. Visual inspection indicating use or missing parts (screws, visors, worn cords, etc.)
3. Structural damage (cracked shell, visor housing, booms, etc.)
4. Structural damage preventing repair and refurbishment (cracked helmet shell, salvage useable part and dispose of helmet shell)
5. Visual inspection for SPH-4 helmets as flight helmets must meet requirements in Instruction Memo No. 96-2006 which states: SPH-4 Helmet should be converted to SPH-5 Helmets or disposed of.
6. Return to inventory if helmet has been unused and carton does not show signs of damage.
7. Send for refurbishment if any item found during inspection such as use or missing parts appear to be repairable
8. Dispose of helmet if structural integrity is compromised. Salvage usable parts.

A. Cleaning

- Use general purpose cleaner. (Do not use bleach, paint remover, thinner, or acetone on flight helmet shell. It may cause damage)

B. Repair

All refurbishment will be conducted by certified personnel (trained by NIFC ramp services).

1. Earphones
2. Microphone
3. Cord assembly

4. Microphone cable assembly
5. Replace missing or damaged parts
6. Replace thermoplastic liner (TPL) in SPH-5 TPL
 - o Size Regular NFES #003063
 - o Size XL- NFES #003064
 - o Size Small NFES #003065. Contact address below for further information.

Refurbishment and repair may be performed by the following:

National Interagency Fire Center Ramp Services
3833 S. Development Avenue Boise, ID 83705
Phone: 208-387-5529 Fax: 208-387-5785

C. Testing for Performance

- Re-test avionics if anything has been repaired or replaced

D. Repackaging

1. Place flight helmet inside helmet bag
2. Package 1 each in carton NSN 8115-00-079-8680, (12" x 12" x 12").

Helmet – Flight, SPH-5C, Regular, w/Bag

NFES Status

Active

NFES #

002314

Category

Aviation

Updated

Mon, 05/01/2017 - 12:00

Storage and Shelf Life Checks

None

Initial Inspection/Disposal Criteria

1. If helmet carton is unopened inspect carton for signs of crushing, drops or water damage. If carton is damaged, open and inspect helmet following remaining inspection processes.
2. Visual inspection indicating use or missing parts (screws, visors, worn cords, etc.)
3. Structural damage (cracked shell, visor housing, booms, etc.)
4. Structural damage preventing repair and refurbishment (cracked helmet shell, salvage useable part and dispose of helmet shell)

5. Visual inspection for SPH-4 helmets as flight helmets must meet requirements in Instruction Memo No. 96-2006 which states: SPH-4 Helmet should be converted to SPH-5 Helmets or disposed of.
6. Return to inventory if helmet has been unused and carton does not show signs of damage.
7. Send for refurbishment if any item found during inspection such as use or missing parts appear to be repairable
8. Dispose of helmet if structural integrity is compromised. Salvage usable parts.

A. Cleaning

- Use general purpose cleaner. (Do not use bleach, paint remover, thinner, or acetone on flight helmet shell. It may cause damage)

B. Repair

All refurbishment will be conducted by certified personnel (trained by NIFC ramp services).

1. Earphones
2. Microphone
3. Cord assembly
4. Microphone cable assembly
5. Replace missing or damaged parts
6. Replace thermoplastic liner (TPL) in SPH-5 TPL
 - Size Regular NFES #003063
 - Size XL- NFES #003064
 - Size Small NFES #003065. Contact address below for further information.

Refurbishment and repair may be performed by the following:

National Interagency Fire Center Ramp Services
3833 S. Development Avenue Boise, ID 83705
Phone: 208-387-5529 Fax: 208-387-5785

C. Testing for Performance

- Re-test avionics if anything has been repaired or replaced

D. Repackaging

1. Place flight helmet inside helmet bag
2. Package 1 each in carton NSN 8115-00-079-8680, (12" x 12" x 12").

Bag – Flight Helmet

NFES Status
Active

NFES #
001269
Category
Aviation
Updated
Mon, 05/01/2017 - 12:00
Storage and Shelf Life Checks
None

Initial Inspection/Disposal Criteria

1. Visual inspection for:
 - Inspect seams for rips or tears. Dispose of item if stitching is torn.
 - Ensure zippers work properly
 - Ensure handles are in good condition
 - Ensure velcro and snap buttons are intact
 - Ensure clips function properly
2. Return to stock if item is clean, free of damage and is in unused condition.
3. Refurbish if item passes inspection, cleaning is required or light repairs are economically feasible
4. Dispose of item if there is any writing or markings on the bag, or if the item is beyond economical repair.

Refurbishment Procedures

A. Cleaning

1. Machine wash with cold water and mild detergent and air dry.

DO NOT USE BLEACH TO CLEAN FABRIC.

B. Repair - Refurbishing Procedures

- Repair any tears, holes or areas of excessive abrasion by sewing any tear 0.25 inches.

C. Testing for Performance

- None

D. Repackage

1. Local cache option for packaging of bags independently.
2. Bags are a component of Flight Helmet, NFES #[002314](#) and #[002315](#). Reference Flight Helmet refurbishment standards for direction on packaging Flight Helmet Bags with Helmets.

